

**DRM270012LT****Weidmüller Interface GmbH & Co. KG**

Klingenbergstraße 26

D-32758 Detmold

Germany

www.weidmueller.com

**Product image**

Similar to illustration

Individual relays within the D-SERIES DRM

- 2 CO contacts
- AC coils
- With integrated status LED and test button

**General ordering data**

Version	D-SERIES DRM, Relay, Number of contacts: 2, CO contact, AgNi flash gold-plated, Rated control voltage: 12 V DC, Continuous current: 10 A, Plug-in connection
Order No.	<a href="#">7760056068</a>
Type	DRM270012LT
GTIN (EAN)	4032248855872
Qty.	20 pc(s).

Creation date December 28, 2021 3:11:02 PM CET

Catalogue status 17.12.2021 / We reserve the right to make technical changes.

## DRM270012LT

**Weidmüller Interface GmbH & Co. KG**

Klingenbergstraße 26

D-32758 Detmold

Germany

www.weidmueller.com

## Technical data

### Dimensions and weights

Depth	35.7 mm	Depth (inches)	1.406 inch
Height	27.4 mm	Height (inches)	1.079 inch
Width	21 mm	Width (inches)	0.827 inch
Net weight	35.3 g		

### Temperatures

Storage temperature	-40 °C...70 °C	Operating temperature	-40 °C...60 °C
Humidity	35...85 % rel. humidity, no condensation		

### Environmental Product Compliance

REACH SVHC	Lead 7439-92-1
------------	----------------

### Rated data UL

Certificate No. (cURus)	E312083
-------------------------	---------

### Control side

Rated control voltage	12 V DC	Rated current DC	75 mA
Power rating	0.9 W	Pull-in/drop-out voltage, typ.	9 V / 1.2 V DC
Coil resistance	160 Ω ± 10 %	Status indicator	Green LED

### Load side

Rated switching voltage	250 V AC	Continuous current	10 A
Max. switching frequency at rated load	0.1 Hz	Min. switching power	10 mA @ 12 V, 100 mA @ 5 V
Inrush current	20 A / 50 ms	AC switching capacity (resistive), max.	2500 VA
DC switching capacity (resistive), max.	240 W @ 24 V	Switch-on delay	≤ 20 ms
Switch-off delay	≤ 20 ms	Contact type	2 CO contact (AgNi flash gold-plated)
Mechanical service life	20 x 10 <sup>6</sup> switching cycles		

### General data

Test button available	Yes		
Mechanical switch position indicator	Yes		
Colour	Transparent		
UL94 flammability rating component	Component	Relay cover	
	UL94 flammability rating	V-2	
	Component	Relay baseplate	
	UL94 flammability rating	V-0	
	Component	Relay status indicator	
	UL94 flammability rating	HB	
	Component	Relay test button	
	UL94 flammability rating	HB	

## DRM270012LT

Weidmüller Interface GmbH &amp; Co. KG

Klingenbergstraße 26

D-32758 Detmold

Germany

www.weidmueller.com

## Technical data

## Insulation coordination

Rated voltage	250 V	Pollution severity	2
Surge voltage category	III	Clearance and creepage distances for control side - load side	≥ 5.5 mm
Dielectric strength for control side - load side	1.8 kV <sub>eff</sub> / 1 min.	Dielectric strength of neighbouring contacts	1 kV <sub>eff</sub> / 1 min
Dielectric strength of open contact	1 kV <sub>eff</sub> / 1 min	Impulse withstand voltage	6 kV (1.2/50 μs)
Protection degree	IP20		

## Further details of approvals / standards

Standards	IEC 61810-1, EN 60664-1:2007, EN 61000-6-2:2005, EN 61000-6-4:2007 + A1:2011, UL 508	Certificate No. (cURus)	E312083
-----------	--	-------------------------	---------

## Connection data

Wire connection method	Plug-in connection
------------------------	--------------------

## Classifications

ETIM 6.0	EC001437	ETIM 7.0	EC001437
ETIM 8.0	EC001437	ECLASS 9.0	27-37-16-01
ECLASS 9.1	27-37-16-01	ECLASS 10.0	27-37-16-01
ECLASS 11.0	27-37-16-01		

## Approvals

Approvals



ROHS	Conform
UL File Number Search	E312083

## Downloads

Approval/Certificate/Document of Conformity	<a href="#">EU Konformitätserklärung / EU Declaration of Conformity</a>
Engineering Data	<a href="#">CAD data – STEP</a>
Engineering Data	<a href="#">EPLAN, WSCAD</a>
Catalogues	<a href="#">Catalogues in PDF-format</a>
Brochures	

**DRM270012LT**

**Weidmüller Interface GmbH & Co. KG**  
 Klingenbergstraße 26  
 D-32758 Detmold  
 Germany

www.weidmueller.com

**Drawings**

**Wiring diagram**

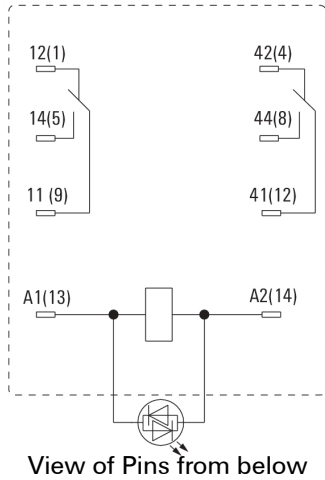

**Graph**

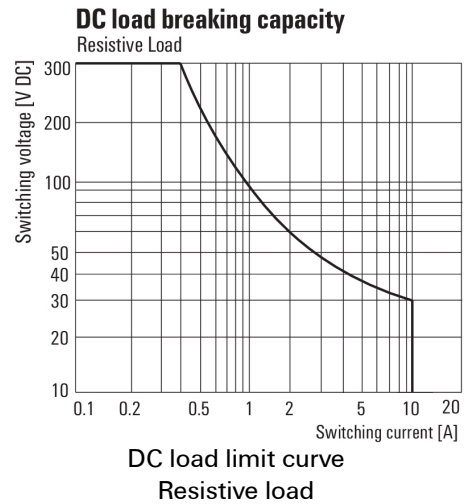

**Graph**

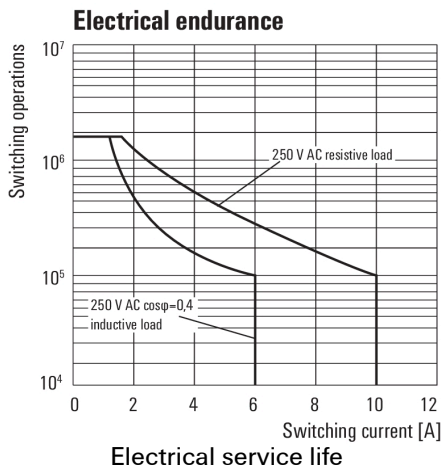

**Graph**

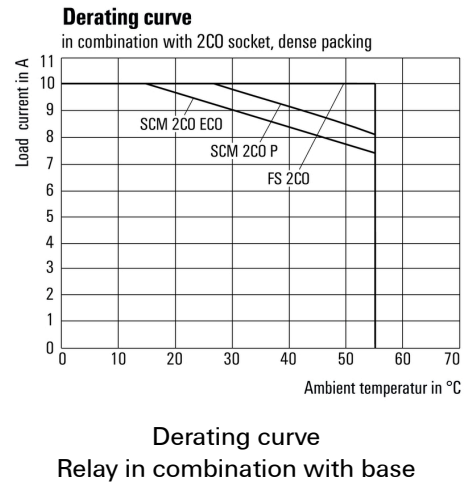

**Graph**

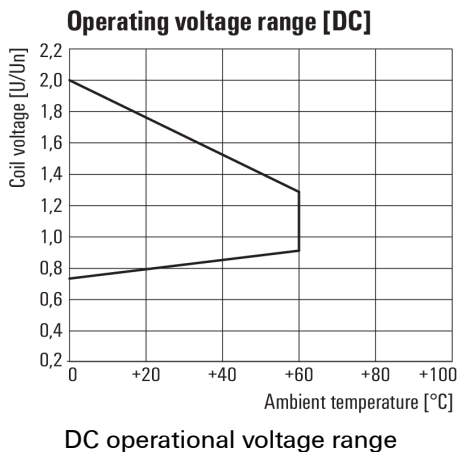

**Dimensional drawing**

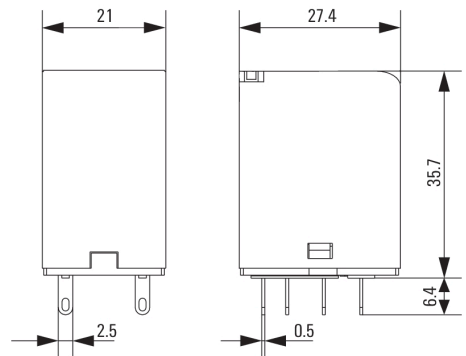

**DRM270012LT**

**Weidmüller Interface GmbH & Co. KG**  
 Klingenbergstraße 26  
 D-32758 Detmold  
 Germany

www.weidmueller.com

**Drawings**

**Miscellaneous**

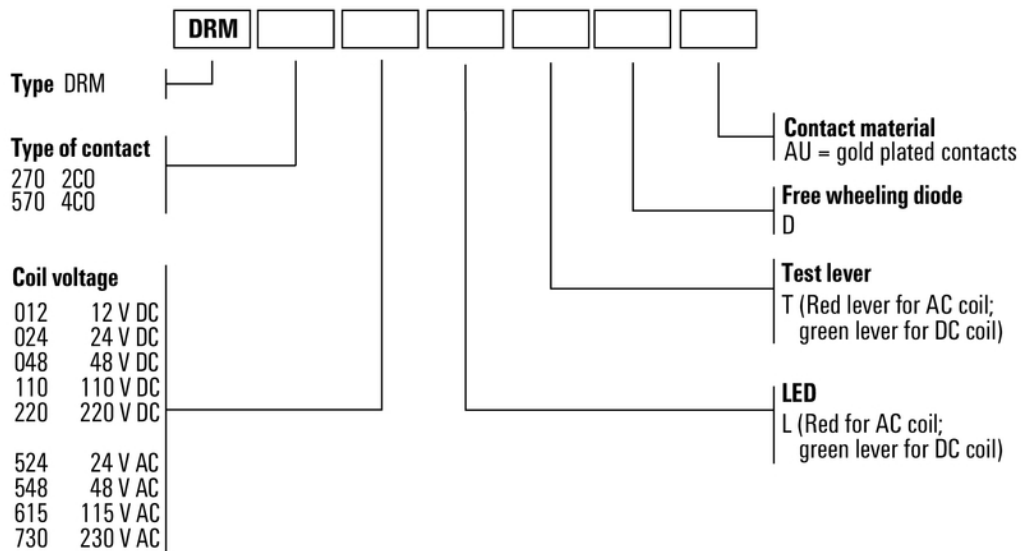

Type codes